

# CLEO SERIES

## HEIGHT ADJUSTABLE ELECTRIC BASES

*Designed to move with you!*



**2 LEG  
& 3 LEG  
MODELS**

**15**  
STRUCTURAL  
WARRANTY  
YEAR

**7**  
MECHANICAL  
WARRANTY  
YEAR

THE  
**IN-STOCK**  
ADVANTAGE

**ECO STORY**

### Features

- Quick Assembly - Fold-out leg frame
- Extended Height Range: 22"- 47.5" (excludes 1" top)
- Sturdy 3-stage steel frame
- 4 programmable memory positions
- Actuator system with synchronized motor driving each leg
- Flexibility - designed to work with most Innovations tops (sold separately) or RETRO FIT your existing top to this unit
- Fits 24" & 30" tops, centered legs for more support
- Product is **IN-STOCK**

### Width Adjustment:

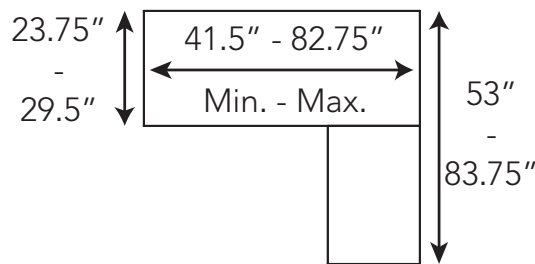
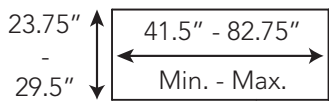

### Base Finishes

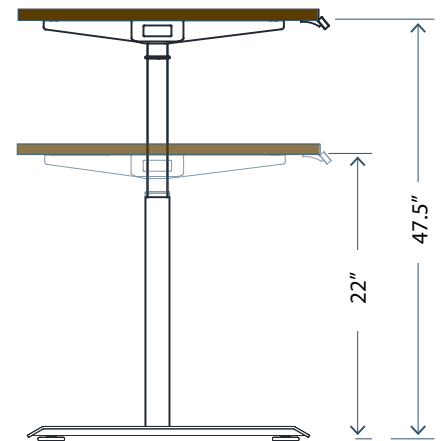
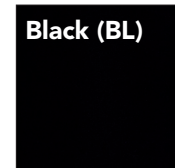

### Model:

CLI-E1-2LEG  
CLI-E1-3LEG

### Description:

Straight Desk  
L Shape Desk



## Technical Specifications:

- Anti-collision function - stops automatically if it hits an immovable object
- Actuator system with synchronized motor driving each leg
- Operated at 1.2" per second
- Whisper quiet <55dB
- Lifting Capacity:
  - 2-LEG - 265lbs
  - 3-LEG - 320lbs
- CSA/UL Certified

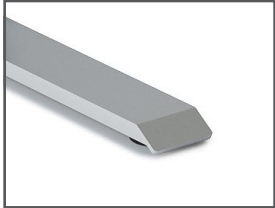

Adjustable glides for easy leveling on uneven surfaces



Easy to use key pad with 4 programmable memory positions



Accessory: Wire Management 100-WM1300

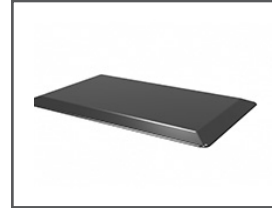

Accessory: Anti-fatigue Mat 100-2030AFM



Accessory: Hanging CPU holder 100-2-HPCU

## Innovations Laminate Tops

### Model:

INV-2436TOP (Return Only)  
 INV-2442TOP  
 INV-2448TOP  
 INV-3060TOP  
 INV-3066TOP  
 INV-3072TOP  
 INV-362466ECM  
 INV-362471ECM

### Description:

35.5"W x 23.75"D x 1"H  
 41.5"W x 23.75D x 1"H  
 47.25"W x 23.75D x 1"H  
 59.25"W x 29.5"D x 1"H  
 65"W x 29.5"D x 1"H  
 71"W x 29.5"D x 1"H  
 65"W x 35.5/23.75"D x 1"H  
 71"W x 35.5/23.75"D x 1"H

### Optional Caster

#### 900-CASTER-M8-MB

- Sold quantity 2 casters  
2 leg base - 2 sets required  
3 leg base - 3 sets required
- Durable PVC material
- Safe for use on soft or hard floors
- M8 threaded stem caster
- Maximum weight 32kg/66lbs per caster



### Examples:

INV-2448TOP	INV-3060TOP	INV-3066TOP	INV-3072TOP	INV-362466ECM	INV-362472ECM	INV-3060TOP	INV-3066TOP	INV-3072TOP
+ CAL-E1-2LEG	+ CAL-E1-2LEG	+ CAL-E1-2LEG	+ CAL-E1-2LEG	+ CAL-E1-2LEG +CAL-E1-2LEG-CMF	+ CAL-E1-2LEG +CAL-E1-2LEG-CMF	INV-2436TOP INV-2442TOP or INV-2448TOP	INV-2436TOP INV-2442TOP or INV-2448TOP	INV-2436TOP INV-2442TOP or INV-2448TOP
						+ CAL-E1-3LEG	+ CAL-E1-3LEG	+ CAL-E1-3LEG

### Laminate Top Finishes:

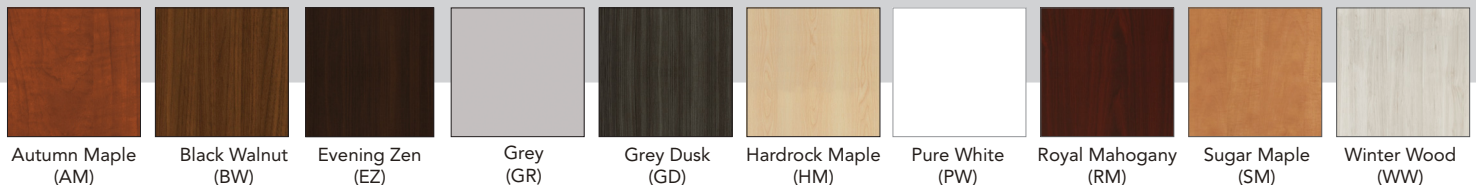

## Heartwood Distributors Ltd.

Choose high quality, price sensitive products that are **IN-STOCK** and ready for next day shipping.  
[www.heartwooddl.com](http://www.heartwooddl.com)

Contact your local dealer:

251 Adams Rd, Kelowna, BC V1X 7R1  
 T: 1 800 567 3060  
 F: 250 765 1213