

CALYPSO SERIES

HEIGHT ADJUSTABLE ELECTRIC BASES

Designed to move with you!



**2 LEG
& 3 LEG
MODELS**

15
STRUCTURAL
WARRANTY
YEAR

7
MECHANICAL
WARRANTY
YEAR

THE
IN-STOCK
ADVANTAGE

ECO STORY

Features

- Quick Assembly - Fold-out leg frame
- Extended Height Range: 22" - 48" (excludes 1" top)
- Heavy duty 3-stage steel frame
- 4 programmable memory positions
- Actuator system with synchronized motor driving each leg
- Flexibility - designed to work with the **NEW** Innovations tops (sold separately) or RETRO FIT your existing top to this unit
- Contemporary offset foot leaves room for keyboard tray or other accessories
- Product is **IN-STOCK**

Base Finishes



Width Adjustment:

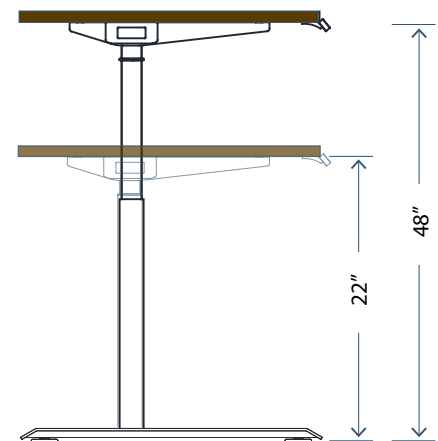
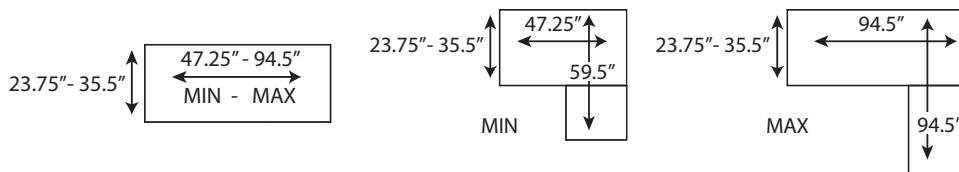

Model:
CAL-E1-2LEG
CAL-E1-3LEG

Description:
Straight Desk
L Shape Desk



Technical Specifications:

- Anti-collision function - stops automatically if it hits an immovable object
- Actuator system with synchronized motor driving each leg
- Operated at 1.3" per second
- Whisper quiet <50dB
- Lifting Capacity: 2-LEG - 265lbs
3-LEG - 320lbs
- CSA/UL Certified
- BIFMA Certified

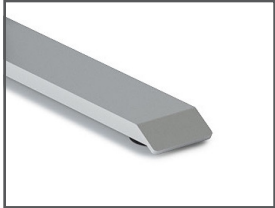

Adjustable glides for easy leveling on uneven surfaces



Easy to use key pad with 4 programmable memory positions



Accessory: Wire Management 100-WM1300

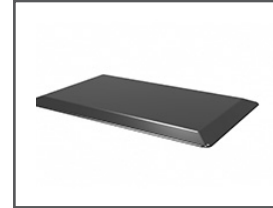

Accessory: Anti-fatigue Mat 100-2030AFM



Accessory: Hanging CPU holder 100-2-HPCU

Innovations Laminate Tops

Model:

INV-2436TOP (Return Only)
 INV-2442TOP
 INV-2448TOP
 INV-3060TOP
 INV-3066TOP
 INV-3072TOP
 INV-362466ECM
 INV-362471ECM

Description:

35.5"W x 23.75"D x 1"H
 41.5"W x 23.75D x 1"H
 47.25"W x 23.75D x 1"H
 59.25"W x 29.5"D x 1"H
 65"W x 29.5"D x 1"H
 71"W x 29.5"D x 1"H
 65"W x 35.5/23.75"D x 1"H
 71"W x 35.5/23.75"D x 1"H







Optional Caster

900-CASTER-M8-MB

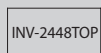
- Sold quantity 2 casters
2 leg base - 2 sets required
3 leg base - 3 sets required
- Durable PVC material
- Safe for use on soft or hard floors
- M8 threaded stem caster
- Maximum weight 32kg/66lbs per caster

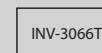

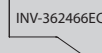
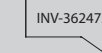
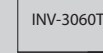
Examples:

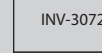
								
+ CAL-E1-2LEG	+ CAL-E1-2LEG	+ CAL-E1-2LEG	+ CAL-E1-2LEG	+ CAL-E1-2LEG +CAL-E1-2LEG-CMF	+ CAL-E1-2LEG +CAL-E1-2LEG-CMF	INV-2436TOP INV-2442TOP or INV-2448TOP + CAL-E1-3LEG	INV-2436TOP INV-2442TOP or INV-2448TOP + CAL-E1-3LEG	INV-2436TOP INV-2442TOP or INV-2448TOP + CAL-E1-3LEG

Laminate Top Finishes:

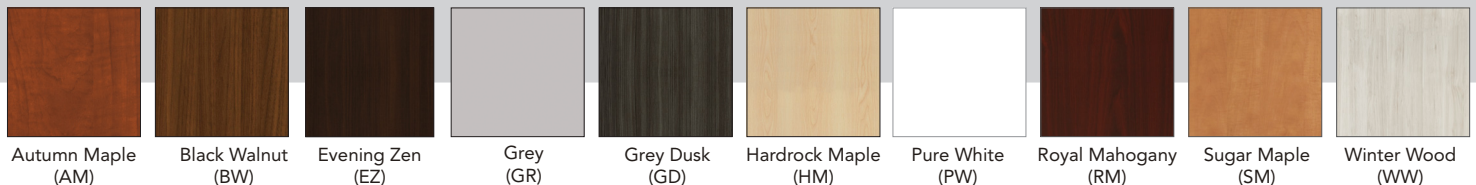

Heartwood Distributors Ltd.

Choose high quality, price sensitive products that are **IN-STOCK** and ready for next day shipping.
www.heartwooddl.com

Contact your local dealer:

251 Adams Rd, Kelowna, BC V1X 7R1
 T: 1 800 567 3060
 F: 250 765 1213