



20
25



HEARTWOOD

DISTRIBUTORS LTD.

LOOKBOOK





Welcome to Heartwood Distributors Ltd.

HDL imports and distributes high-quality office and institutional furniture, serving an extensive dealer network across Canada.

If you're looking for high-quality, price-sensitive office furniture, seating, and accessories, our products are all IN-STOCK at our Langley, BC and Markham, ON warehouses for quick shipping.

Can't find what you need? HDL items can be fully integrated with products from Heartwood Manufacturing Ltd.

Discover the Heartwood Advantage!



Reception

A two-tone finish blends seamlessly into any office, creating a welcoming atmosphere the moment clients walk in.

Designed with functionality in mind, this desk features a built-in cubby for efficient storage, keeping your workspace neat and organized.

Featured Products

- ① INV-3072GDS3
- ② INV-2436GRS3
- ③ INV-2237STC
INV-2236OLFX
INV-STCHDRS-AL
- ④ INV-MPF
INV-MPF-CUSHFA

FEATURING EVENING ZEN/PURE WHITE
LAMINATE AND ALUMINIUM GLAZED DOORS



Outlines Reception

A huge advantage of Outlines Series is its flexibility.

Combine post and panels to span the desired length and add a transaction top where needed.

This product can form part of a new desk setup or can be retrofit to an existing desktop simply and easily.

Featured Products

- ① INV-7236CM
- ② INV-2436RSBR
- ③ INV-HPF
- ④ OUT-12POST
OUT-1272PYP
OUT-INV7272CTA

FEATURING EVENING ZEN LAMINATE AND
ALUMINIUM POSTS/RAILS



Boardroom

Quality, choice and value are key ingredients that define the Innovations series.

Combining high quality furniture with an abundance of components and finishes to choose from, along with our "in-stock", next day delivery advantage, makes this the perfect choice for your boardroom.

Complete your boardroom with seating from our Jupiter series.

Featured Products

- ① INV-2236OLFX
- ② INV-2237STC
- ③ INV-STCHDRS-AL
- ④ INV-2236CX
- ⑤ INV-2272TOP
- ⑥ INV-SQ48
- ⑦ INV-PSE96
- ⑧ INV-PSE48
- ⑨ HER-MB-BL

FEATURING WINTERWOOD LAMINATE AND
ALUMINIUM GLAZED DOORS
SEATING - HERA MID-BACK TASK CHAIRS



Workstations

The Innovations series consists of over 100 components available in 7 different finishes. More than just good value, Innovations has the designer edge and the flexibility needed in the modern workspace to accommodate individual needs.

Featured Products

- | | |
|--------------------|-----------------|
| ① INV-6532BK | ⑦ FRM-3648P |
| ② INV-32BKDRS | ⑧ FRM-1036PLX |
| ③ INV-3072TBL-LOOP | ⑨ 900-SQB20-CFT |
| ④ INV-2436RET-LOOP | ⑩ INV-SQ24 |
| ⑤ ZEU-MB | ⑪ COU-2SEAT |
| ⑥ INV-MPUF | |



FEATURING GREY DUSK LAMINATE WITH SILVER METAL.
SEATING - ZEUS MID-BACK TASK CHAIR



FEATURING BLACK WALNUT/PURE WHITE
LAMINATE WITH BLACK METAL.
SEATING - ZEUS MID-BACK TASK CHAIR

Height Adjustable Office

Multi-tiered, layered office furniture series that combines contemporary metal details with durable laminate designs.

Featured Products

- | | |
|--------------------|----------------|
| ① LEV-R2230COX-21 | ⑥ 100-MA2 |
| ② LEV-2266NTOP-R | ⑦ LEV-MPF |
| ③ LEV-2236WDLFX-21 | ⑧ ZEU-MB-BL |
| ④ CAL-E1-2LEG | ⑨ LEV-SR7232BK |
| ⑤ LEV-3072TOP | ⑩ LEV-32BKDRS |

Home Office

Uniquely designed products offer exceptional style and excellent quality for office work at home.

Combined with storage from Innovations or Levels Series, you will have a place for everything.

Featured Products

- ① LEV-6532BK
- ② LEV-32BKDRS
- ③ ZEU-MB-DG
- ④ MA-12-3060
- ⑤ LEV-2236CX-SR28
- ⑥ LEV-2236COX-SR28
- ⑦ LEV-2272TOP

FEATURING WINTERWOOD LAMINATE, SILVER METAL RISERS.

SEATING - ZEUS MID-BACK IN DARK GREY





Desktop Partions

These panels are compatible with new or retrofitted desk assemblies and edge mount panels can also be installed in temporary applications as brackets are secured to the underside of a work surface.

Featured Products

- ① OBO-MBPU
- ② INV-3060TOP
- ③ ATH-E1-2LEG
- ④ OUT-TM1-2560PET
- ⑤ INV-R36
- ⑥ 900-ROU20
- ⑦ ZUM-MB-TASK

FEATURING GREY DUSK LAMINATE WITH BLACK METAL.

SEATING - OBO MID-BACK TASK CHAIR AND ZUMA TASK CHAIR WITH CUSHION



FEATURING GREY DUSK LAMINATE WITH
SILVER METAL
SEATING - ZEUS MID BACK TASK CHAIR
ZUMA MID BACK CHAIR WITH CUSHION

Height Adjustable Stations

Sit-to-Stand Height Adjustable Electric Bases available in both 2 leg and 3 leg models. Can be used with the full range of Innovations laminate tops (sold separately) as well as Accessories.

Featured Products

- ① ATH-E1-3LEG
INV-362472ECM
INV-2436TOP
- ② INV-MP1-1566PLX
- ③ 100-MA1
- ④ INV-3072TBL-SQ2OFT
- ⑤ INV-1668MB

- ⑥ INV-1736OS
- ⑦ INV-72HDRS-AL
- ⑧ INV-SQ48
900-SQ2OFFSET
- ⑨ ZUM-MB
- ⑩ 100-MMPF

Panel Systems

Define your space within the ever changing office environment with HDL's Framework series, an IN-STOCK, commercial grade, quick to install, freestanding modular panel system.

Featured Products

- ① FRM-4848P
- ② INV-2448TOP
- ③ INV-6518WC
- ④ FRM-1036PLX
- ⑤ ZEU-MB-DG
- ⑥ 100-AKTM-2
- ⑦ INV-362472ECM
- ⑧ INV-2436RET-LOOP
- ⑨ INV-MPF
- ⑩ INV-CUSH

FEATURING WINTERWOOD LAMINATE WITH SILVER METAL.

SEATING - ZEUS MID-BACK TASK CHAIR





Upscale Meeting Spaces

These table bases create the perfect centerpiece for any boardroom. Available through HDL IN-STOCK, these high-quality tables feature a sleek, modern design.

Pair with seating options from the Jupiter line to create the ultimate meeting space.

Featured Products

- ① INV-REC14448-MUP
- ② JUP-IRIS-MB
- ③ COU-B-1SEAT
- ④ COU-B-2SEAT
- ⑤ INV-COFFEE-SQ24

FEATURING BLACK WALNUT LAMINATE WITH CHROME AND SILVER LEGS.

SEATING - IRIS MID BACK AND ATTICUS SOFT SEATING

Small Meeting Spaces

Featured Products

- ① INV-R42-MUP
- ② JUP-BARCELONA
- ③ AUR-MB
- ④ INV-RTE9648
- ⑤ INV-PSE96
- ⑥ INV-3072TBL-SQ2OFT

FEATURING GREY DUSK LAMINATE WITH
CHROME AND SILVER LEGS.
SEATING - AURA MID BACK TASK CHAIRS





Lunchroom

Using a combination of our bar height, counter height and table height bases - setup your lunchroom to meet all seating needs.

Featured Products

- ① ZUM-BAR-SLED
- ② NOV-PUPU-02
- ③ ZUM-MB-SLED
- ④ INV-R36
- ⑤ 900-CROSS-B-27
- ⑥ INV-SQ36
- ⑦ 900-CNTR27
- ⑧ ZUM-CNTR-SLED

FEATURING WINTERWOOD LAMINATE WITH SILVER METAL BASES.
SEATING - ZUMA SLED CHAIRS AND NOVA



Training Room

Tucana - The Elite Series is a versatile solution for virtually any group or gathering and it's IN-STOCK. These high quality tables nest together maximizing space with their unique interlocking leg design.

Featured Products

- ① HAD-PU
- ② TU-98B-2472TBL

FEATURING PURE WHITE LAMINATE WITH SILVER METAL BASES.

SEATING - HADES TRAINING CHAIRS

HEARTWOOD DISTRIBUTORS LTD. LIMITED LIFETIME WARRANTY - LAMINATE OFFICE FURNITURE

HDL wishes to assure dealers and customers who purchase our products that they are investing in the best quality furniture available in its class. To this end, any laminate furniture products supplied by HDL on or after February 1st, 2012 are warranted to be free from defects in materials and workmanship for as long as the original purchaser owns the product. Please refer to our Limited Lifetime Warranty document for exceptions. In the unlikely event that any product or component covered by this warranty should fail under normal workplace conditions, as described and limited in this document, HDL promises to repair it. If we are unable to repair it, we will replace it with comparable product.

This warranty is limited to manufacturer's defects and will not apply to any products that must be repaired or replaced due to normal wear and tear, negligence, abuse or installation errors. Products that have been modified or altered by others or used for rental purposes are not covered. This warranty covers materials only, labour and shipping costs for repair or replacement are not covered.

HDL reserves the right to change laminate, fabric and hardware suppliers and, as a result, we do not guarantee the match of colours, grain or hardware to those of existing products.

This warranty, as explained here, is your sole and exclusive remedy. To make a warranty claim, Proof of Purchase must be presented.

Please refer to our Warranty process document to be certain you have provided all of the information we require to ensure an accurate and speedy resolution.



HEARTWOOD DISTRIBUTORS LTD
251 ADAMS RD KELOWNA BC, VIX 7R1

PRODUCT INFORMATION PAGES

<i>UPSCALE</i>	20
<i>ZEUS</i>	21
<i>IRIS</i>	22
<i>HERA</i>	23
<i>BARCELONA</i>	24
<i>AURA</i>	25
<i>NOVA</i>	26
<i>HADES</i>	27
<i>OBO</i>	28
<i>ZUMA - MID-BACK, COUNTER AND BAR HEIGHT</i>	29
<i>ZUMA - TASK</i>	30
<i>ATTICUS</i>	31
<i>SOFT SEATING</i>	32
<i>METAL ROUND BASES</i>	33
<i>METAL SQUARE BASES</i>	34
<i>METAL CROSS BASES</i>	35
<i>METAL SQUARE OFFSETS LEGS</i>	36
<i>INNOVATIONS TOPS</i>	37
<i>INNOVATIONS DESKING</i>	38
<i>LEVELS TABLES</i>	39
<i>INNOVATIONS PEDESTALS</i>	40
<i>LEVELS MOBILE PEDESTALS</i>	41
<i>METAL MOBILE PEDESTALS</i>	42
<i>CALYPSO HEIGHT ADJUSTABLE BASE</i>	43

<i>ATHENA HEIGHT ADJUSTABLE BASE</i>	44
<i>OUTLINES PLUS PANELS</i>	45
<i>OUTLINES DESKTOP PANEL & POST SYSTEM</i>	46
<i>INNOVATIONS MODESTY PANELS</i>	47
<i>GLASS DRY ERASE WHITEBOARD</i>	48
<i>OVERHEAD STORAGE</i>	49
<i>FRAMEWORK</i>	50
<i>FRAMEWORK PANELS</i>	51
<i>INNOVATIONS CREDENZAS</i>	52
<i>LEVELS CREDENZAS</i>	53
<i>MIRA DESK</i>	54
<i>INNOVATIONS TABLES</i>	55
<i>INNOVATIONS BOOKCASES & DOORS</i>	56
<i>LEVELS BOOKCASES & DOORS</i>	57
<i>ELITE TRAINING TABLES</i>	58
<i>INNOVATIONS BOARDROOM TABLES & BASES</i>	59
<i>PNEUMATIC MONITOR ARMS</i>	60
<i>ARTICULATING KEYBOARD</i>	61
<i>INNOVATIONS WARDROBE</i>	62
<i>INNOVATIONS MODERN RECEPTION</i>	63

UPSCALE

- Inset extruded black aluminum frame creates a sturdy, lightweight, base without compromising leg space and allows for maximizing seating capacity
- Features sleek contoured angled legs in your choice of Black (BL) or Chrome (CR)

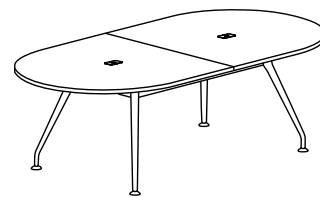
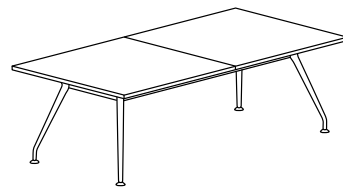

Laminate Finishes:

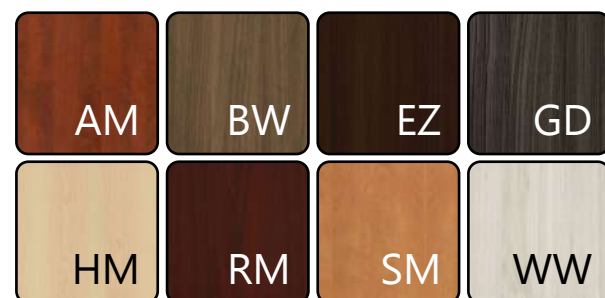

Base Finishes:



- ◀ Workstations Page 6
- ◀ Height Adjustable Office Page 7
- ◀ Home Office Page 8
- ◀ Panel Systems Page 11

[RETURN TO PRODUCT INFORMATION PAGES INDEX](#)



ZEUS

Mid-Back Task/Meeting Chair

- Premium polyurethane or fabric seat & backrest
- Weight activated synchro-tilt function (automatically adjusts to an individual user)
- 4 position tilt-lock
- 4D armrest adjustment (width, front & back, up & down movement and inward rotation)
- Seat-depth adjustment
- Non-marking dual-wheel polyurethane casters, ideal for hard or soft surfaces
- Assembled in Canada from globally sourced materials
- ANSI/BIFMA approved construction x 5.1-2017

Chair Dimensions:

Back Height: 41" - 44.9"
 Seat Height: 16.5" - 19.9"
 Seat Depth: 21"
 Seat Width: 20.5" - 22.5"
 Arm Width: 19"
 Max Recommended Weight Capacity: 300lbs

Base Finishes:

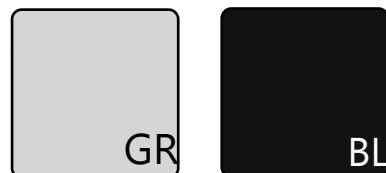

Polyurethane Finishes:



Fabric Finish:



Model: ZEU-MB-DG-GR



IRIS

Mid-Back Task/Meeting Chair

- Sling style back with rolled and pleated details
- Polyurethane (PU) upholstery, padded with comfortable high-density foam
- Pneumatic seat height adjustment
- Multi-position knee tilter
- Chromed aluminum fixed arms
- Polished aluminum base
- Sturdy internal steel frame
- Dual wheel casters, ideal for soft or hard floors
- ANSI/BIFMA approved construction
- Easy to clean
- Quick assembly

Chair Dimensions:

Back Height: 37" - 39"

Seat Height: 18" - 20"

Seat Depth: 18.5"

Seat Width: 19"

Arm Width: 22.5"

Max Recommended Weight Capacity: 300lbs

Fabric Finishes:



Model: JUP-IRIS-MBPU



Also available in High-Back

HERA

Mid-Back Task/Meeting Chair

- Black meshed back for greater air circulation and comfort
- Pneumatic seat height adjustment
- Loop armrests
- Tilt-Tension adjustment
- Dual wheel casters carpet casters
- ANSI/BIFMA approved construction
- Sold in multiples of 2 only
- Assembly required

Chair Dimensions:

Back Height: 37.75" - 41"
Seat Height: 16.75" - 20.5"
Seat Depth: 19"
Seat Width: 19"
Arm Width: 23"
Max Recommended Weight Capacity: 350lbs

Fabric Finishes:



Model: HER-MB-BL



BARCELONA

Mid-Back Task/Meeting Chair

- One piece seat, back, and fixed arm frame
- German K&R tight-knit mesh seat and back
- Sleek swivel tilt function
- Seat height adjustment with low-profile German cable control mechanism
- Durable nylon base
- Dual wheel casters, ideal for soft or hard floors
- ANSI/BIFMA approved construction
- Quick assembly

Chair Dimensions:

Back Height: 34.5" - 39"
Seat Height: 17" - 21.5"
Seat Depth: 18"
Seat Width: 19"
Arm Width: 22.25"
Max Recommended Weight Capacity: 300lbs

Fabric Finishes:



Model: JUP-BARCELONA-BL



AURA

Mid-Back Task/Meeting Chair

- Upholstered, high density moulded foam seat & mesh back
- Multi-position tilt lock & tilt tension adjustment
- Adjustable lumbar support
- Pneumatic seat height adjustment
- Fixed height polyurethane pad armrest
- Dual wheel casters, ideal for soft or hard floors
- ANSI/BIFMA approved construction

Chair Dimensions:

Back Height: 38.75" - 42.5"
Seat Height: 17" - 21"
Seat Depth: 20"
Seat Width: 20.75"
Arm Width: 19.25"
Max Recommended Weight Capacity: 300lbs

Fabric/Mesh Finishes:

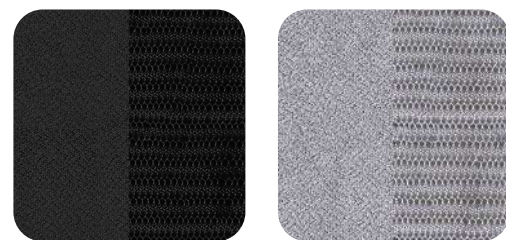

BL

GR



Model: AUR-MB-GR



NOVA

Guest Chair

- Available with any combination of mesh or black polyurethane back paired with fabric or black polyurethane seat cushion
- Available with or without armrests
- Durable, 4-leg steel frame
- Stackable - up to 5 units high
- Assembly required

Chair Dimensions:

Back Height: 37.75" - 41"
 Seat Height: 16.75" - 20.5"
 Seat Depth: 19"
 Seat Width: 19"
 Arm Width: 23"
 Max Recommended Weight Capacity: 350lbs



Model: NOV-PUFA-01-BL



Base Finishes:

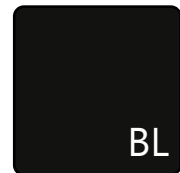

BL

Fabric Finishes:

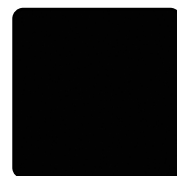

BL

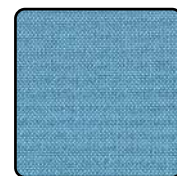

BU

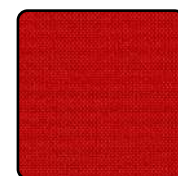

RD



OR

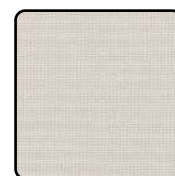

GR

Polyurethane Finish:



BL

HADES

Training Chair

- Contoured mesh back with fabric seat
- Flip-up seat for easy storage, nest multiple chairs
- Durable grey steel frame
- Dual wheel casters, ideal for soft or hard floors
- Black polyurethane arm caps
- Quick assembly required
- Sold in quantities of 2

Chair Dimensions:

Back Height: 34.5"
 Seat Height: 19"
 Seat Depth: 19.25"
 Seat Width: 18"
 Arm Width: 19.25"
 Max Recommended Weight Capacity: 275lbs

Fabric Finishes:



BL

Polyurethane Finish:



BL



Model: HAD-PU-BL



OBO

Mid-Back Multi-Tilter Chair

- Polyurethane (PU) seat and back multi-tilter
- Infinite position tilt-lock and tilt-tension adjustment
- Pneumatic seat height adjustment
- Ergonomically designed back with lumbar support
- Independent back angle adjustment
- Ratchet back height adjustment
- Adjustable seat depth
- 4D height adjustable arms
- Durable Nylon base
- Non-marking dual wheel casters, ideal for carpet, hardwood, vinyl, and tile floors
- ANSI/BIFMA X5.1-2017 approved construction

Chair Dimensions:

Back Height: 39.5" - 45.5"
Seat Height: 18" - 21.5"
Seat Depth: 18"
Seat Width: 20"
Arm Width: 25.75"

Max Recommended Weight Capacity: 300lbs

Polyurethane Finish:



BL

Model: OBO-MBPU-BL



ZUMA - MID-BACK, COUNTER AND BAR HEIGHT

- Comfortable contoured polypropylene seat
- Sturdy Steel Frame
- Non-marking feet
- Chairs can be stacked 10 units high
- Quick Assembly
- Optional cushion available
- Table Seat Height: approximately 17.5"
- Counter Seat Height: approximately 23.5" - only available with Sled base
- Bar Seat Height: approximately 29.5"
- Sold in cartons of 4
- Seat Dimension: 18" deep x 18.25" wide



Model: ZUM-MB-SLED-ARM-WH



Model: ZUM-MB-SLED-WH



Model: ZUM-CNTR-SLED-WH



Model: ZUM-BAR-SLED-WH
Shown with Optional Seat Cushion



Model: ZUM-MB-WH



Model: ZUM-BAR-WH



Model: ZUM-SLED-CART-BL
Shown with Mid-back sled chairs

Optional Cushion Fabric Finishes:

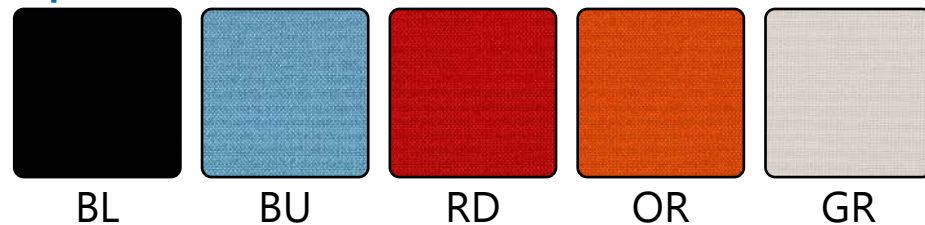

Polyurethane Finish:

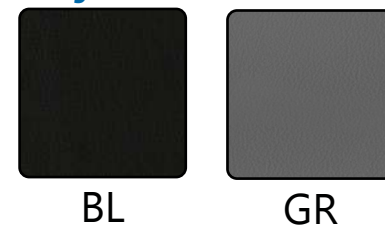

Seat Finishes:

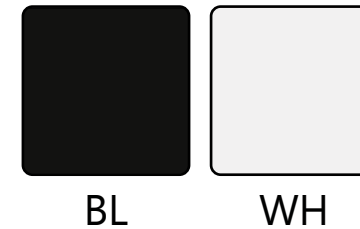

Base Finishes:



ZUMA - TASK

- Comfortable contoured polypropylene seat
- Sold as Individuals
- Quick Assembly
- Optional cushion available - sold in Qty of 4
- Pneumatic Seat-height adjustment
- Dual wheel casters, ideal for soft or hard floors
- Seat Height: approximately 17.5"- 23"
- Seat Dimension: 18" deep x 18.25" wide



Model: ZUM-TASK-WH
Shown with Optional Seat Cushion



Model: ZUM-TASK-WH - back view
Shown with Optional Seat Cushion



Model: ZUM-TASK-WH

Optional Cushion Fabric Finishes:

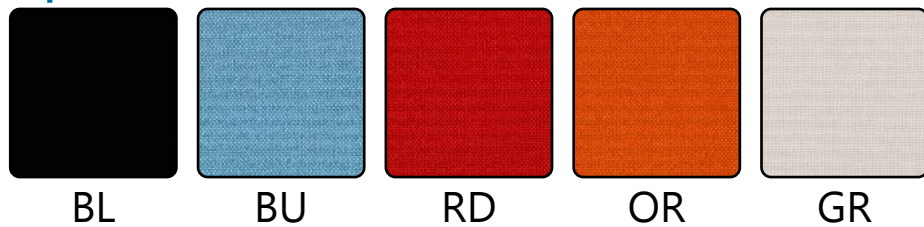

Polyurethane Finish:

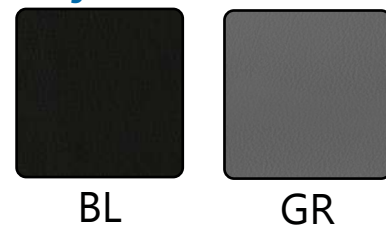

Seat Finishes:

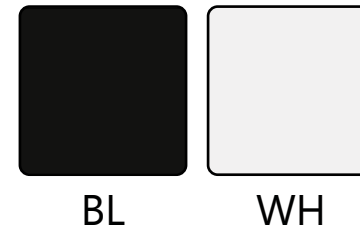

Base Finishes:

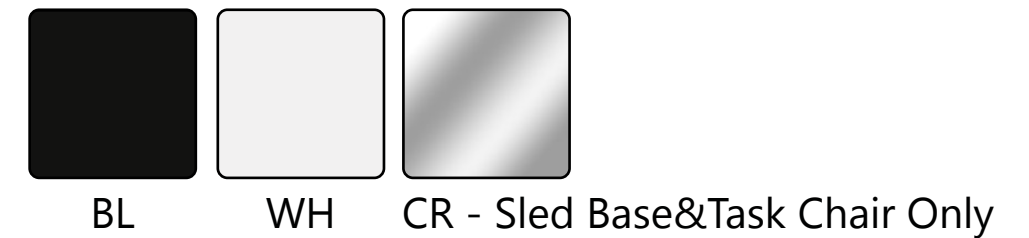

ATTICUS

- Easy Clean Black Polyurethane Seats
- Solid Wood frame construction & plush cushion with high-density foam for comfort
- Sturdy angled steel legs. Available in Black (BL) or Chrome (CR)
- Manufactured to exceed 1000,000 double rubs & meet or exceed ANSI/ BIFMA REQUIREMENTS
- The 1 seater couch has a recommended maximum weight capacity of 300lbs
- The 2-seater & 3 seater couches have a recommended maximum weight capacity of 500lbs & 750lbs
- 3 Year Warranty



Model: COU-B-1SEAT-BL



Model: COU-B-2SEAT-BL



Model: COU-B-3SEAT-BL



Polyurethane Finish:



BL

Leg Finish:



BL

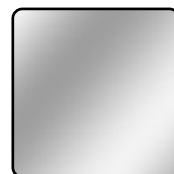

CR

SOFT SEATING

- Plush cushion with high-density foam for comfort
- Easy to clean black polyurethane seat
- Solid wood frame construction
- Sturdy steel leg with contemporary tapered design in a black powder-coat finish
- Manufactured to exceed 100,000 double rubs
- Meets or exceeds ANSI/BIFMA requirements
- 1 seat couch has a recommended maximum weight capacity of 300lbs
- The 2-seater & 3-seater couches have a recommended maximum weight capacity of 500lbs & 750lbs
- 5-year warranty



Model: COU-1SEAT-BL



Model: COU-2SEAT-BL



Model: COU-3SEAT-BL

Polyurethane Finish:



BL

Leg Finish:



BL

METAL ROUND BASES

- Available in 3 heights - 16", 28" and 41"
- Includes Levellers



Shown: INV-R36-GD with 900-ROU20-SL

Base Finishes:

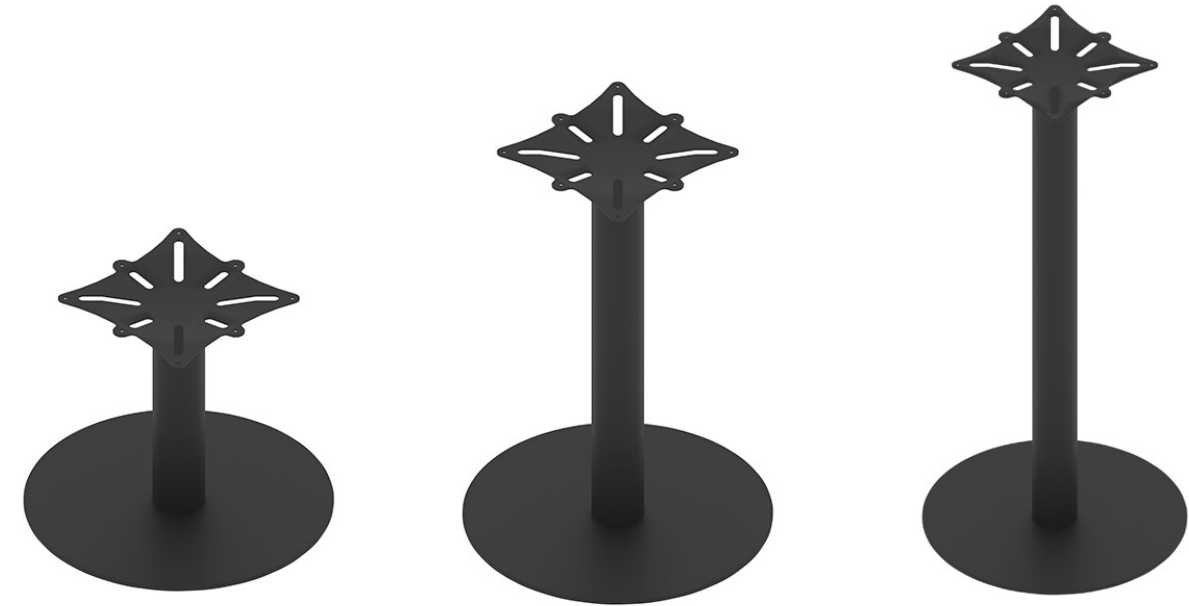
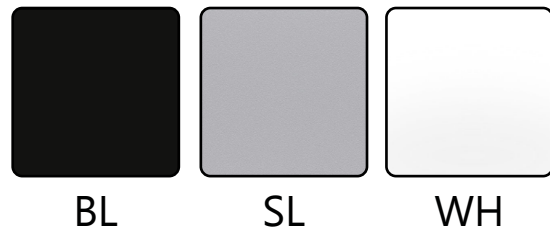

Model: 900-ROU20-BL

Model: 900-ROU20-BL

Model: 900-ROU20BAR-BL

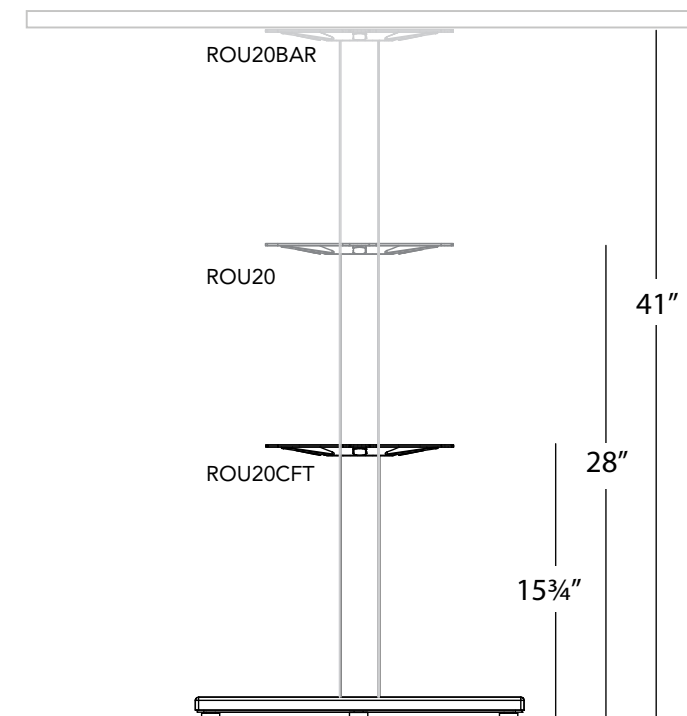

METAL SQUARE BASES

- Available in 3 heights - 16", 28" and 41"
- Includes Levellers



Shown: INV-SQ36-EZ with 900-SQB20-BL

Base Finishes:

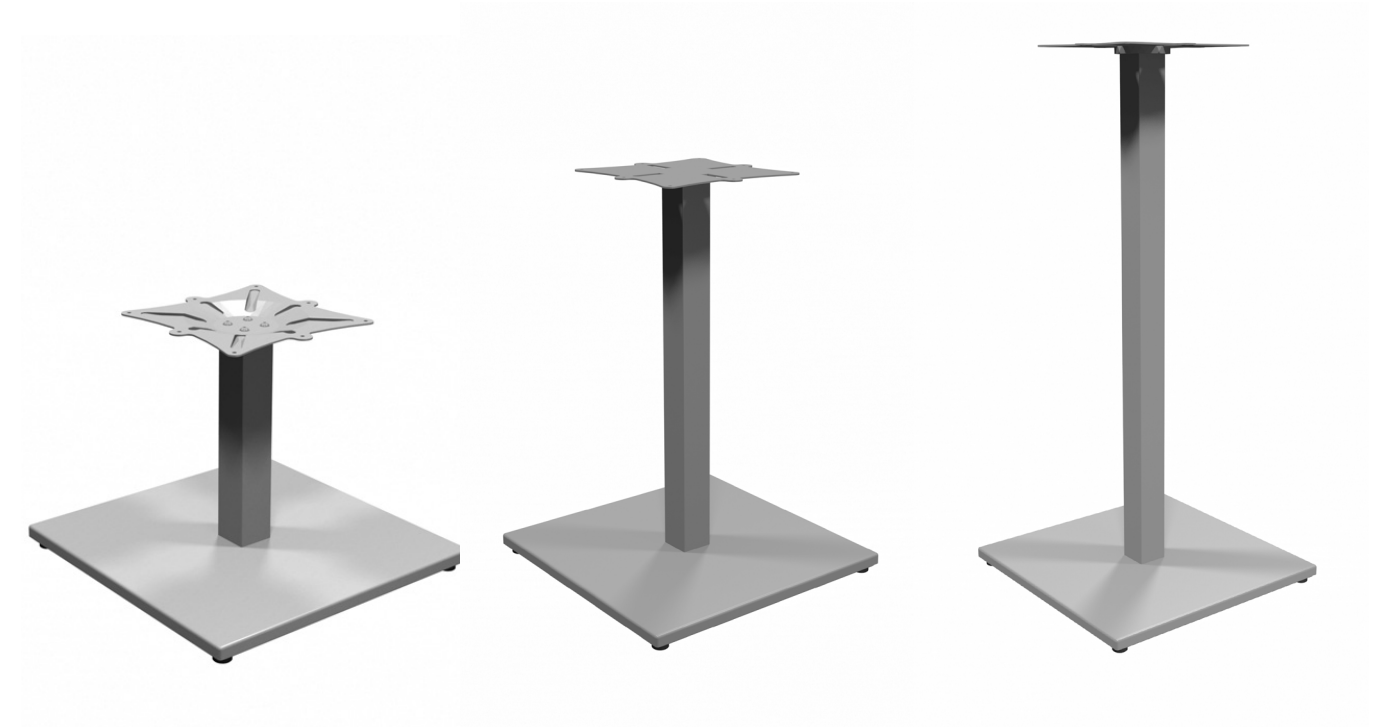
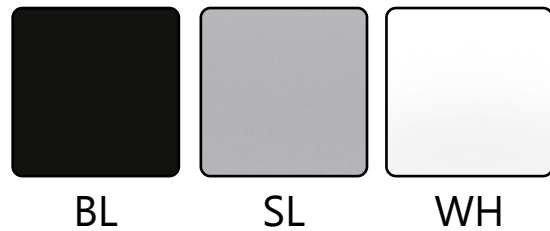

Model: 900-SQB20CFT-BL

Model: 900-SQB20-SL

Model: 900-SQB20BAR-SL

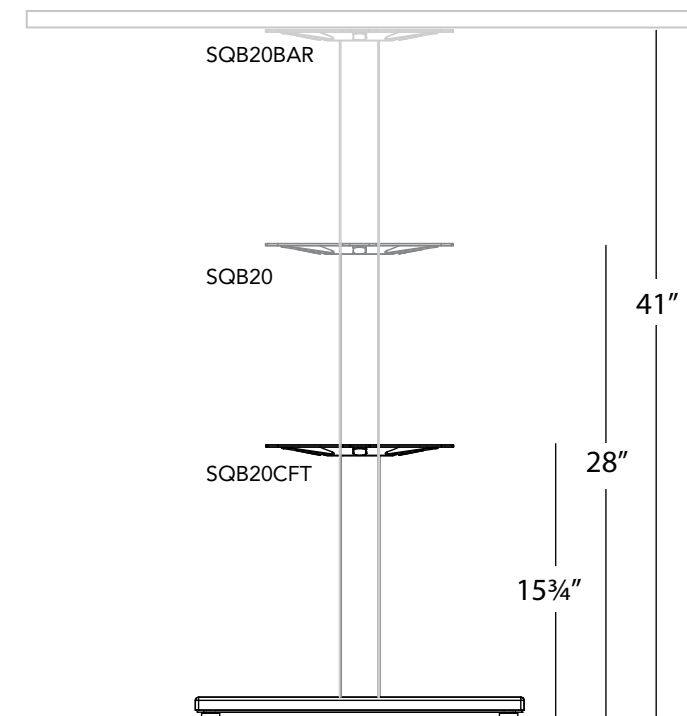

METAL CROSS BASES

- Heavy duty durable 27" wide base
- Low profile adjustable glides
- Available in two heights - 28.5" and 34.5"
- Compatible with Innovations and Levels tops



Shown: INV-R42 with 900-CROSS-B-27

Base Finishes:

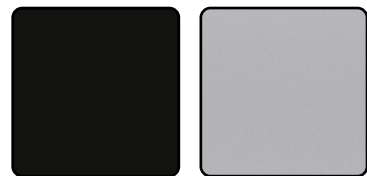

BL

SL



Model: 900-CROSS-B-27-BL



Model: 900-CNTR27-BL

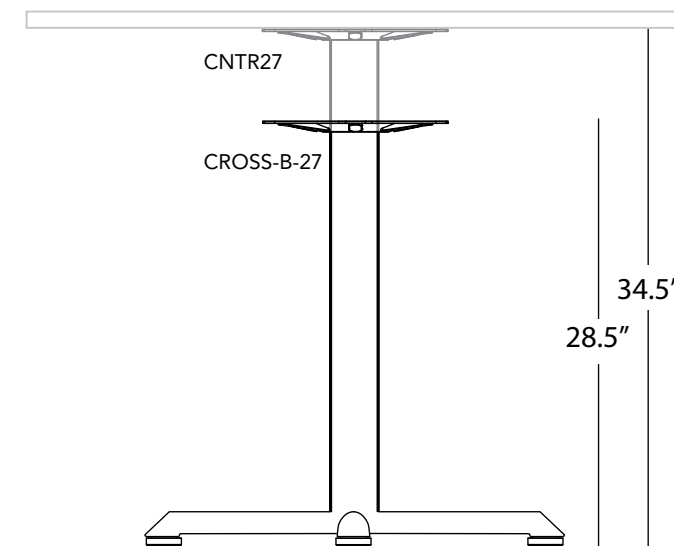

METAL SQUARE OFFSETS LEGS

- 2" square leg with offset top plate creates a contemporary, modern table profile
- Available in two heights - 28" and 15"
- Metal, powder coated



Shown: INV-COFFEE-REC2436-BW-SL

Base Finishes:

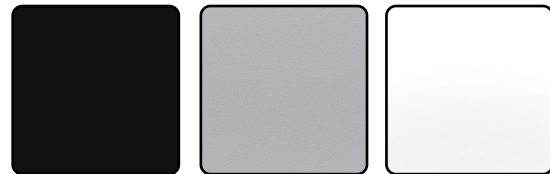

BL

SL

WH



Model: 900-SQ2OFFSET-SL



Model: 900-SQ2-COFFEE-LEGS-BL

- 🔍 Workstations Page 6
- 🔍 Desktop Partions Page 9
- 🔍 Height Adjustable Stations Page 10
- 🔍 Panel Systems Page 11
- 🔍 Lunchroom Page 14

[RETURN TO PRODUCT INFORMATION PAGES INDEX](#)



INNOVATIONS TOPS

- Commercial grade quality with high density thermally fused laminate
- Durable matching 2mm edge banding
- Designed for quick and easy assembly
- Meets or exceeds ANSI & BIFMA standards
- Fully customizable with Heartwood Manufacturing 388 Series - over 3,000 standard SKU's



Model: INV-3060TOP-GD



Model: INV-R36-WW

Laminate Finishes:

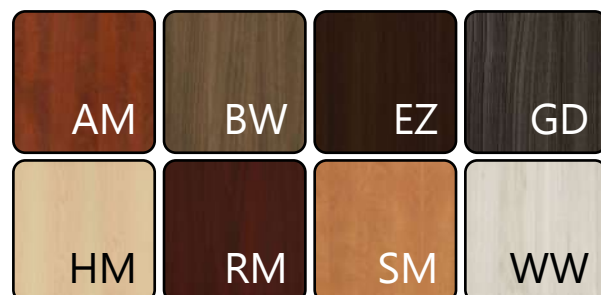

INNOVATIONS DESKING

- Commercial grade quality with high density thermally fused laminate
- Durable matching 2mm edge banding
- Designed for quick and easy assembly
- Meets or exceeds ANSI & BIFMA standards
- Fully customizable with Heartwood Manufacturing 388 Series - over 3,000 standard SKU's



Model: INV-7236CM-GD



Model: INV-2436RSBR-GD

Laminate Finishes:

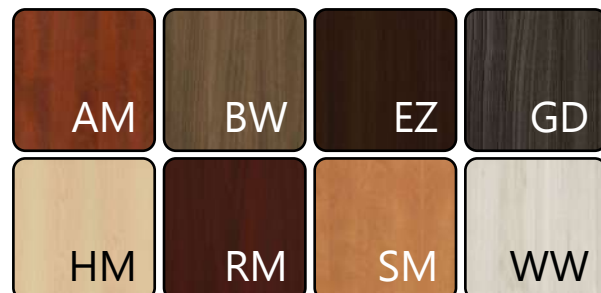

LEVELS TABLES

- Available in a range of sizes and bases from flip top training tables to height adjustable desks
- Commercial grade quality with high density thermally fused laminate
- Select models are Made-in-Canada
- Durable matching 2mm edge banding
- Designed for quick and easy assembly
- Meets or exceeds ANSI & BIFMA standards
- Fully customizable with Heartwood Manufacturing Levels Series - over 3,000 standard SKU's
- Coordinates with Innovations series for additional SKU's



Model: LEV-LAYOUT 1 shown with Grey Dusk tops, Pure White storage



Model: LEV-3072TBL-TU72-GD

Laminate Finishes:



Storage Riser Finishes:



- 🔍 Reception Page 3
- 🔍 Outlines Reception Page 4
- 🔍 Workstations Page 6
- 🔍 Panel Systems Page 11

[RETURN TO PRODUCT INFORMATION PAGES INDEX](#)



INNOVATIONS PEDESTALS

- All boxes and file drawers mounted on full extension ball bearing slides, 75lb load rating
- File drawers features side rails and adjustable file bars that accommodate front to back letter or side to side legal sized hanging folders
- One pencil tray included with every box drawer unit
- All drawers lock
- Mobile Pedestal have 2 locking and 2 non locking casters



Model: INV-MPUF-BW



Model: INV-HPF-GD



Model: INV-MPF-WW



Model: INV-MPF-AM - SHOWN WITH CUSHION

Laminate Finishes:

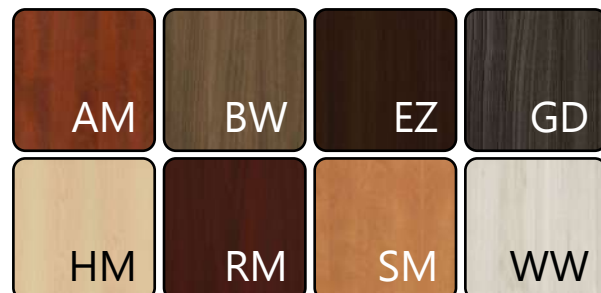

LEVELS MOBILE PEDESTALS

- All boxes and file drawers mounted on full extension ball bearing slides, 75lb load rating
- File drawers features side rails and adjustable file bars that accommodate front to back letter or side to side legal sized hanging folders
- One pencil tray included with every box drawer unit
- All drawers lock
- 2 locking and 2 non locking casters



Model: LEV-MPUF-WW



Model: LEV-MPF-WW

Laminate Finishes:



METAL MOBILE PEDESTALS

- All drawers are steel, commercial grade construction
- Pedestal drawers have radius drawer fronts
- Each file drawer will hold letter or legal sized hanging folders
- Ships fully assembled
- Optional cushion available for the 100-MMPF-TT units
- Can be keyed alike to other metal or laminate storage



Model: 100-MMPUF-TT



Model: 100-MMPFF-TT



Model: 100-MMPF-TT

Metal Finishes:

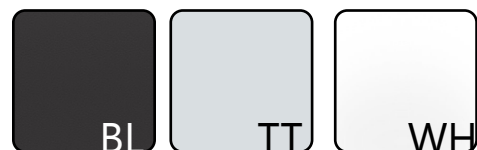

Cushion Colors - MMPF only



CALYPSO HEIGHT ADJUSTABLE BASE

- Quick Assembly - Fold-out leg frame
- Height Range: 22"- 48" high (not including a top)
- Compatible with Innovations tops
- Heavy duty 3-stage steel frame
- Actuator system with synchronized motor driving each leg
- Anti-collision function
- CSA/UL Certified
- BIFMA Certified
- 4 programmable memory positions
- Whisper quiet <50dB
- Max weight capacity: 2 leg base - 265 lbs / 3 leg base - 320 lbs
- Limited lifetime warranty on laminates
- 15 year warranty on structural components
- 7 year warranty on mechanical components

Base Finishes:

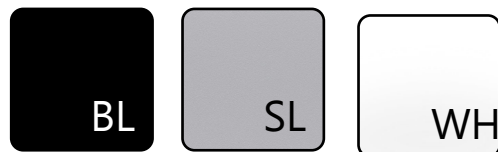

Model: CAL-E1-2LEG-BL



Model: CAL-E1-3LEG-BL

ATHENA HEIGHT ADJUSTABLE BASE

- Modern, tiered design series
- Commercial grade quality with high density thermally fused laminate
- Select models are Made-in-Canada
- Durable matching 2mm edge banding
- Designed for quick and easy assembly
- Meets or exceeds ANSI & BIFMA standards
- Fully customizable with Heartwood Manufacturing Levels Series - over 3,000 standard SKU's
- Coordinates with Innovations series for additional SKU's
- Quick assembly design
- Sturdy, 2-stage, steel frame construction
- ANSI/BIFMA Certified
- Operates at 1" per second
- Whisper quiet <50dB
- 4 programmable memory positions
- Actuator system with synchronized motor driving each leg
- Includes adjustable glides
- Centered legs
- Lift capacity: 220 lbs

Base Finishes:



Model: ATH-E1-2LEG-BL



Model: ATH-E1-3LEG-BL

OUTLINES PLUS PANELS

- Simple bracket & panel desktop privacy panel system.
- Two mounting options - Top Mount (TM1) & Edge Mount (EM1). Edge Mount panels are removable as they attach with screws to the underside of the work surface
- Available in frosted plexiglass, laminate, tackboard, and acoustic PET finishes.
- Available in 15" and 22" heights
- Brackets are durable, high-quality zinc material

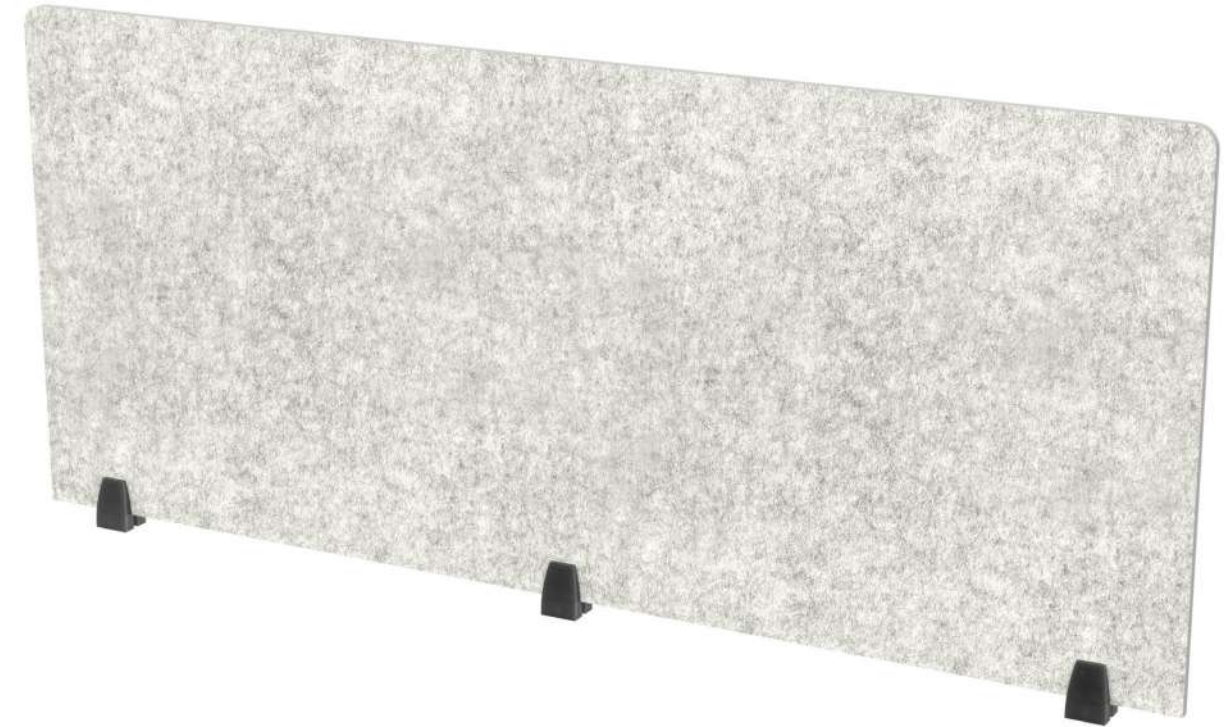

Model: OUT-TM1-2572PET-ST-BL

Laminate Panel Finish:

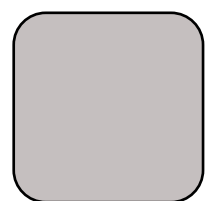

Grey (GR)

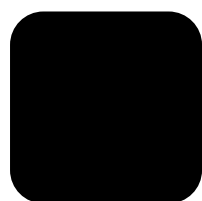

Black (BL)

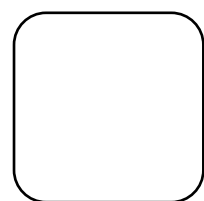

Pure White (PW)

Plexi Panel Finish:

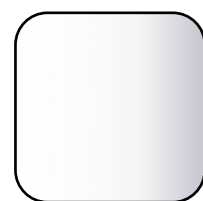

Frosted (FR)

PET Panel Finish:

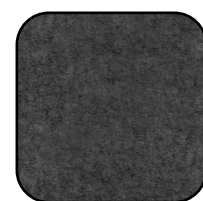

Charcoal Grey (CH)

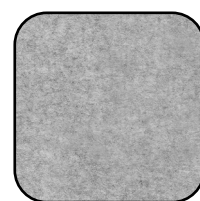

Storm Grey (ST)

Tackboard Panel Finish:

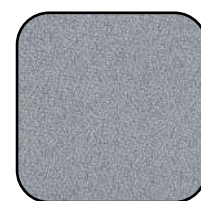

Grey (GR)

Bracket Finish:



Black (BL)

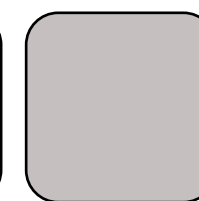

Silver (SL)

OUTLINES DESKTOP PANEL & POST SYSTEM

- Reed Style polycarbonate screen with powder-coated aluminium top and bottom mounting rails
- Optional transaction tops are 1" thick
- All tops are 45lb industrial particle board core with thermally fused laminate
- Top mount posts include PVC filler strips



Model: OUT-INV7272CTA-GD



Polycarbonate Panel Detail

Laminate Finishes:

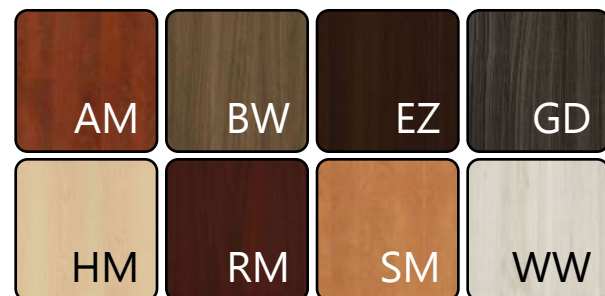

Post/Rail Finishes:



Model: OUT-12POST-AL



Model: OUT-12POST-BL

INNOVATIONS MODESTY PANELS

- Plexi Panels sized to be inset 2" on each side when installed on like size worksurface
- Plexi panels available in 30,48,60 and 66 inch widths
- 30",36",42" and 48" laminate panels are full width
- 60",66" and 72" laminate panels are inset 1" on each side
- Brackets are durable, high-quality zinc material - available in black or silver for plexi panels and black for laminate panels
- 6mm radius corners on plexi panels



Model: INV-MP1-1460LAP

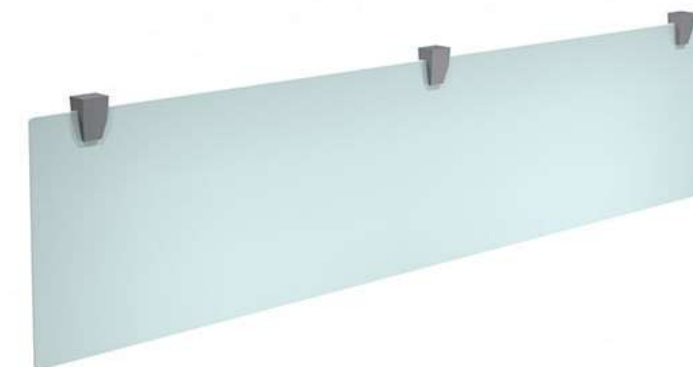

Model: INV-MP1-1566PLX



Laminate Finishes:



Plexi Panel Finish:



Bracket Finish:



GLASS DRY ERASE WHITEBOARD

- Available in 2 sizes - 16"x68" and 24"x34"
- Suitable for wall mount application
- 16"x68" will fit inside the 72" hutch
- All mounting hardware included



Model: INV-1668MB



Model: INV-2434MB

Glass Finish:

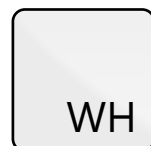

OVERHEAD STORAGE

- Predrilled for Optional soft closed hinged laminate or aluminium glazed doors
- 14.5" inside clearance
- Top between gables design



Model: INV-1736OS-BL



Model: INV-1736OS-BL with Aluminium Glazed Doors

Overhead Laminate Finishes:



FRAMEWORK

- Available in 48" or 66" heights
- 48" tall panels available in 5 sizes
- 66" tall panels available with all fabric or clear glazed panel
- 66" tall panels available in 8 sizes
- 66" tall glazed panels available in 3 sizes

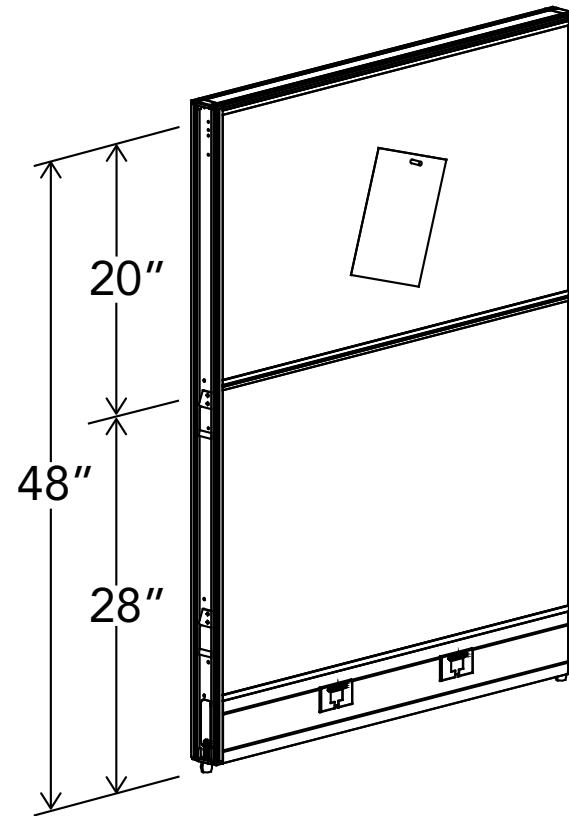

Model: FRM-3048P

Panel Finish:



Charcoal Metal Frame with Grey Fabric Panel



Model: FRM-3066P

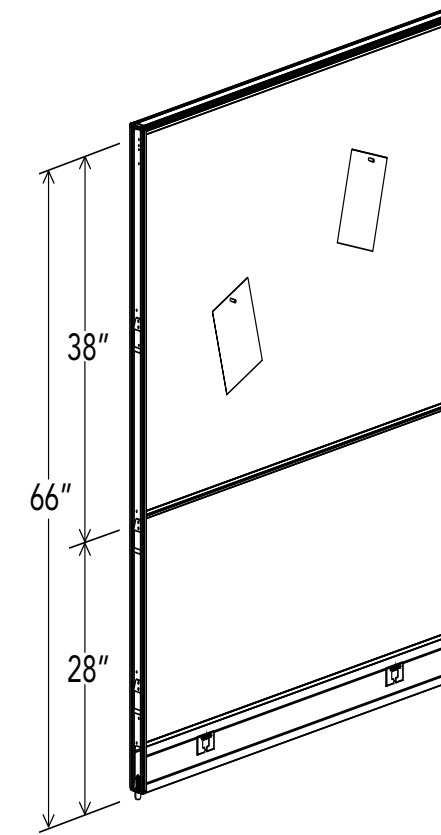

Model: FRM-3066GP

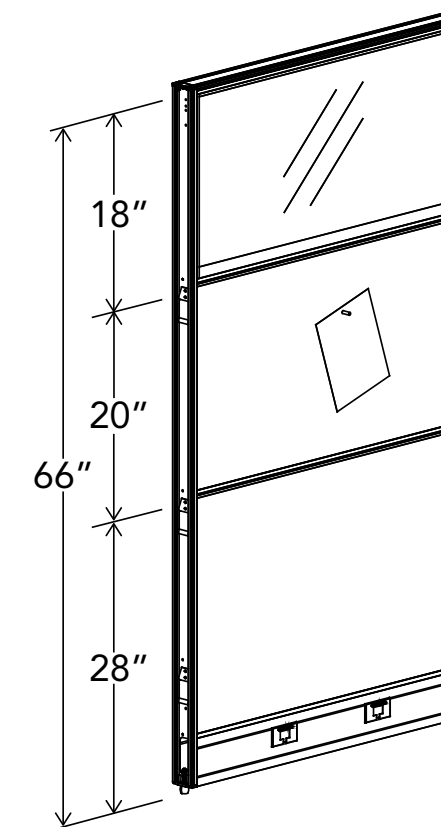

FRAMEWORK PANELS

- 9 3/4" high panel extension
- Can be installed on 48" or 66" high panels
- Includes mounting hardware
- Brackets are available in Black or Silver finishes (silver is the default)
- Frosted Plexiglass finish
- Retrofit to existing Framework Panels
- Available in 24", 30", 36", 42" and 48" widths

Panel Finish:



Charcoal Metal Frame
with Grey Fabric Panel

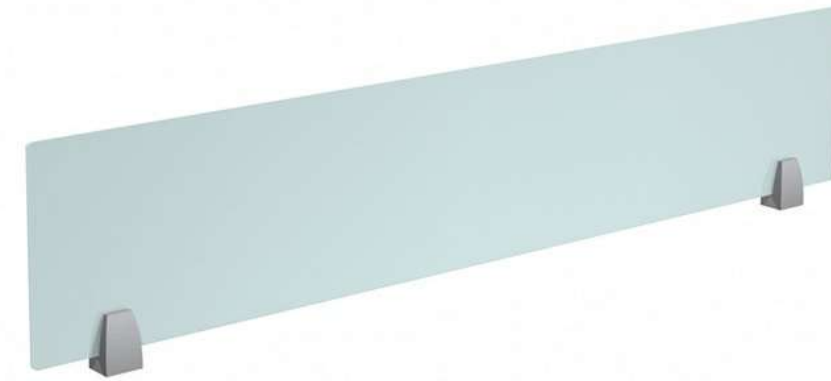

Model: FRM-1048PLX-FR



FRM-1048PLX-FR shown on FRM-4848P-GR

INNOVATIONS CREDENZAS

- Laminate cabinet doors are locking with soft close hinges
- Cabinets include 1 adjustable shelf
- All drawers are installed on full extension ball bearing slides
- Combine the Innovations storage units to meet your storage/filing needs
- Optional Aluminium Glazed doors available for cabinets



Model: INV-2236OLFX-HM with INV-2237STC-HM



Model: INV-2236LFX & INV-2236CX with Aluminium Glazed Doors



Model: INV-2236CX x2 with INV-2272TOP

Laminate Finishes:

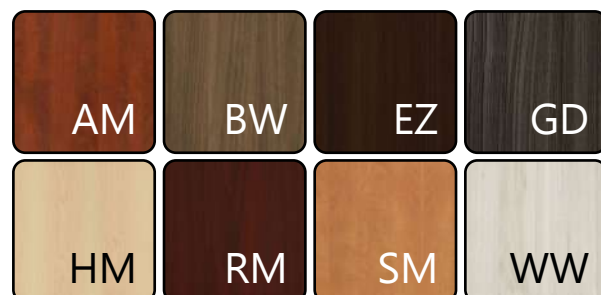

LEVELS CREDENZAS

- Cabinet includes 2 locking soft close hinges and 1 adjustable shelf
- Open cabinet includes 1 adjustable shelf
- Optional 7" high contemporary storage riser feet available
- Fully customizable with Heartwood Manufacturing Levels series
- Notched top and open cabinet with recessed back allows for a hidden foot design with height adjustable bases
- Coordinates with Innovations series for additional SKU's



Model: LEV-2236CX-SR28-WW + LEV-2236CX-SR28-WW with LEV-2272TOP-WW



Model: LEV-LAYOUT 3 - Open cabinet has recessed back with notched top to hide leg of height adjustable base.

Laminate Finishes:



Storage Riser Finishes:



MIRA DESK

- Commercial grade 1 " thick laminate
- Heat, scratch, and dent resistant
- Innovative floating top styling
- Box drawer stores desk accessories
- File drawer stores letter or legal size files
- Shipped Ready-to-Assemble



Model: MA-12-3060-WW - Only available in Winterwood Finish



Model: MA-11-2448-GD

Laminate Finishes:



- 🔍 Workstations Page 6
- 🔍 Height Adjustable Stations Page 10
- 🔍 Panel Systems Page 11
- 🔍 Small Meeting Spaces Page 13

[RETURN TO PRODUCT INFORMATION PAGES INDEX](#)



INNOVATIONS TABLES

- Tops are commercial grade quality high density thermally fused laminate
- Durable matching 2mm edge banding
- Sturdy Metal loop legs have an elegant triangle loop profile
- 2" square leg with offset top plate creates a contemporary, modern table profile



Model: INV-3060TBL-LOOP-GD with INV-2436RET-LOOP-GD SHOWN WITH INV-MPUF-GD

Laminate Finishes:

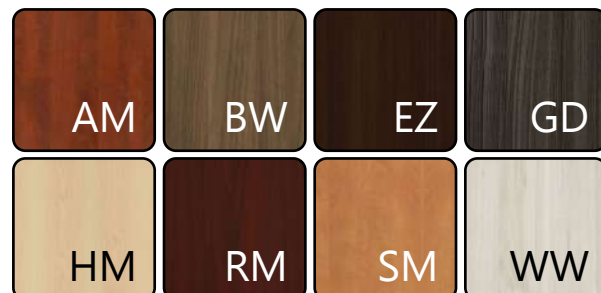

Base Finishes:



Model: INV-3066TBL-SQ2OFT-GD

INNOVATIONS BOOKCASES & DOORS

- Available in 3 heights - 48", 65" and 72"
- 48" high unit includes 2 fixed and 1 adjustable shelf
- 65" high unit includes 2 fixed and 2 adjustable shelves
- 72" high unit includes 2 fixed and 3 adjustable shelves
- Optional bookcase door set available for all units
 - 48" high - installed bottom only
 - 65" high - installed top or bottom
 - 72" high - installed top, bottom or both



Model: INV-4832BK-WW



Model: INV-4832BK-WW with INV-32BKDRS



Model: INV-6532BK-WW



Model: INV-7232BK-WW

Laminate Finishes:

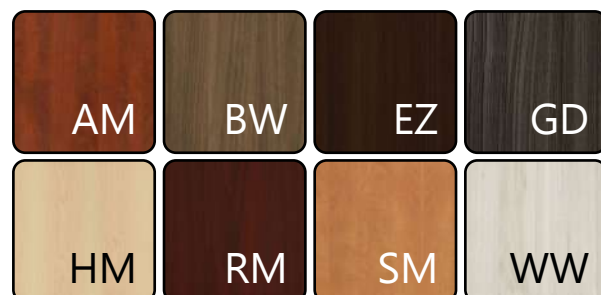

LEVELS BOOKCASES & DOORS

- Available in 2 heights - 65" and 72"
- Includes 2 fixed and 2 adjustable shelves
- Optional door sets available



Model: LEV-6532BK with LEV-32BKDRS



Model: LEV-SR7232BK

Laminate Finishes:



Storage Riser Finishes:



ELITE TRAINING TABLES

- Finished in your choice of 4 laminate colors, with a grey powder-coated metal base
- Features a commercial grade 1" thick top with durable 2mm matching edge paired with formed, mobile steel legs, frame, and modesty panel
- Maximize space with flip top position
- Industry leading space saver in nested position - only 4" between units
- Smooth glide casters for easy movement
- Safe and secure - locking casters position units in place



Model: TU-98B-2472TBL-GD

Laminate Finishes:



INNOVATIONS BOARDROOM TABLES & BASES

- Available in Racetrack or Rectangle shape tops
- Create tables from 8' to 24' using a combination of racetrack and square tops



Model: INV-RTE9648 with INV-PSE96



Model: INV-SQ48 with INV-PSE48

Laminate Finishes:

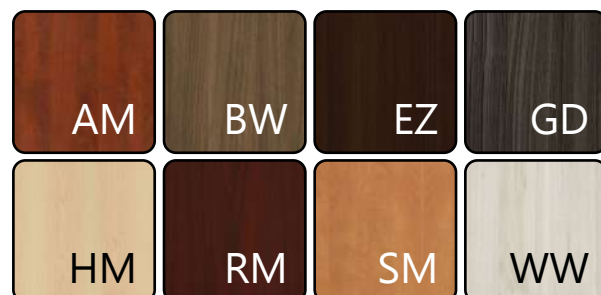

PNEUMATIC MONITOR ARMS

- Fits monitors 13" to 30"
- Available in single or dual arm
- Can add optional laptop holder
- Load capacity up to 16lbs per arm
- Clamp to desk or grommet mount



Monitor Arm Finishes:

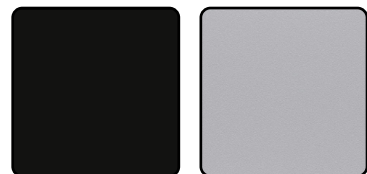

BL

SL



Model: 100-MA1-BL



Model: 100-MA2-BL



Model: 100-LPTP-BL

ARTICULATING KEYBOARD

- Large 26" w x 9.7" d tray
- Holds up to 2.2 lbs
- Height adjustment – 4 ¼"
- Tilting adjustment - 16° / +20°
- Telescoping tray slides completely under the work surface
- Requires 13 ½" of depth clearance under the work surface
- Optional brackets to lower the mechanism and clear obstructions under the work surface. Clears 2 ¼"
- Vinyl wrapped MDF construction with customizable wrist rest

Laminate Finishes:

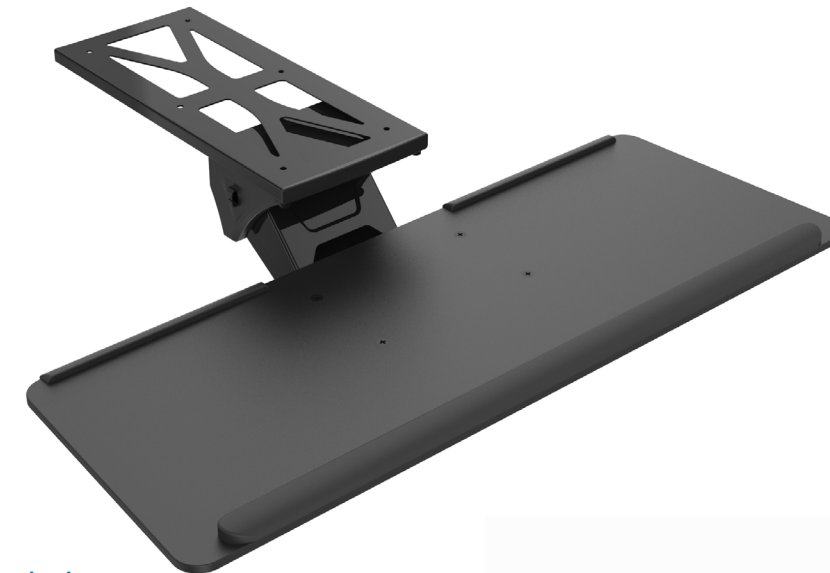
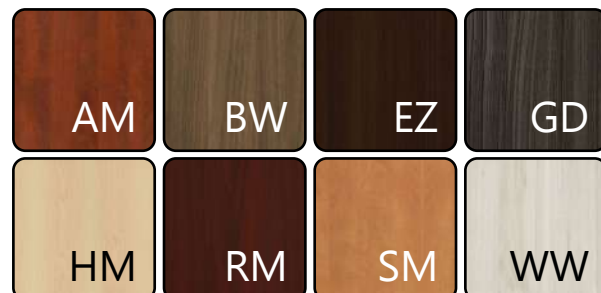

Model: 100-AKTM-2-BL



INNOVATIONS WARDROBE

- Door optional
- Reversible door installation
- Multiple interior cavity configurations
- Hat-shelf, boot-shelf & coat rod
- Aftermarket lock available



Model: INV-6518WC

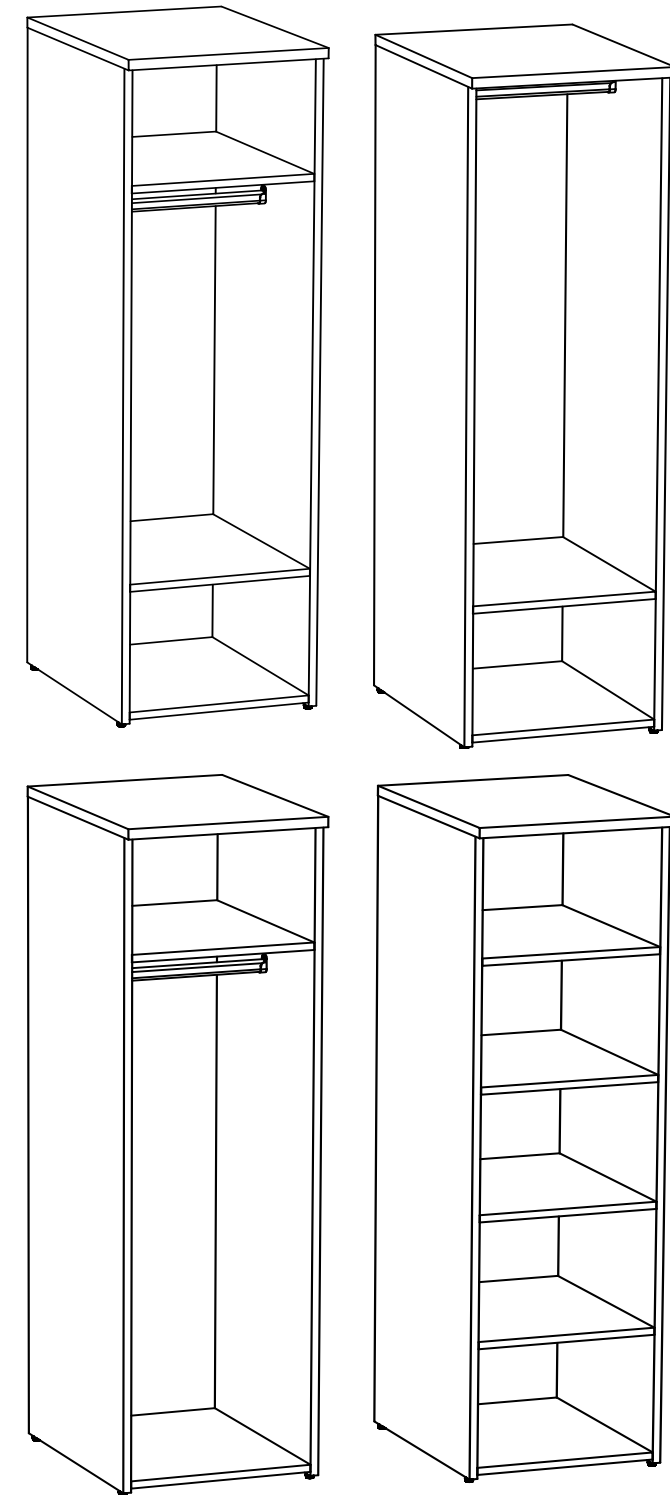

Laminate Finishes:

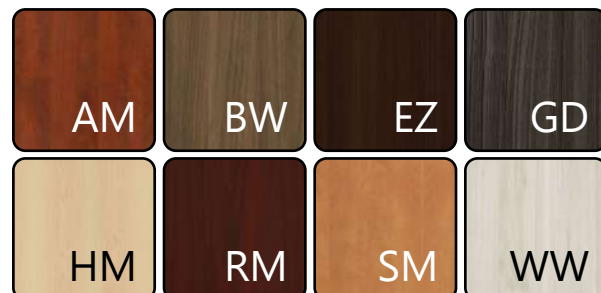

INNOVATIONS MODERN RECEPTION

- Stylish Modern Design
- Non-handed return configuration
- Contemporary two-tone finish
- Built-in cubby-hold transaction top
- Custom designed modesty panel metal spacers



Model: INV-3072GDS3 & INV-2436GRS3



Modesty panel metal spacers

Laminate Finishes:

